

a ~

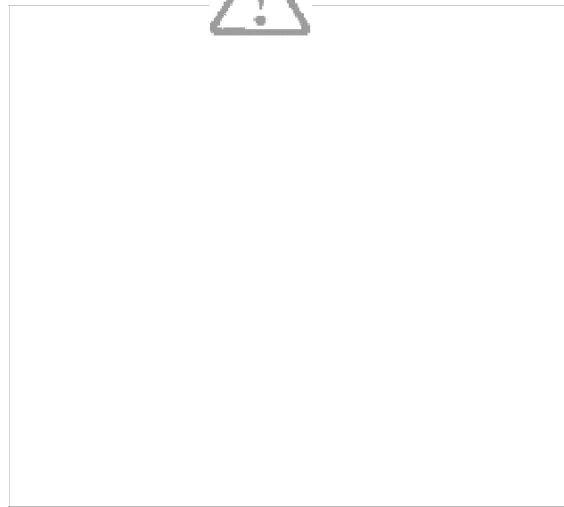

	2
	3
	5
	15
	17
	18
1.	18
2	19
	20
1.	20
2	22
3	23
4.	24
	25
1.	25
2	25
	26

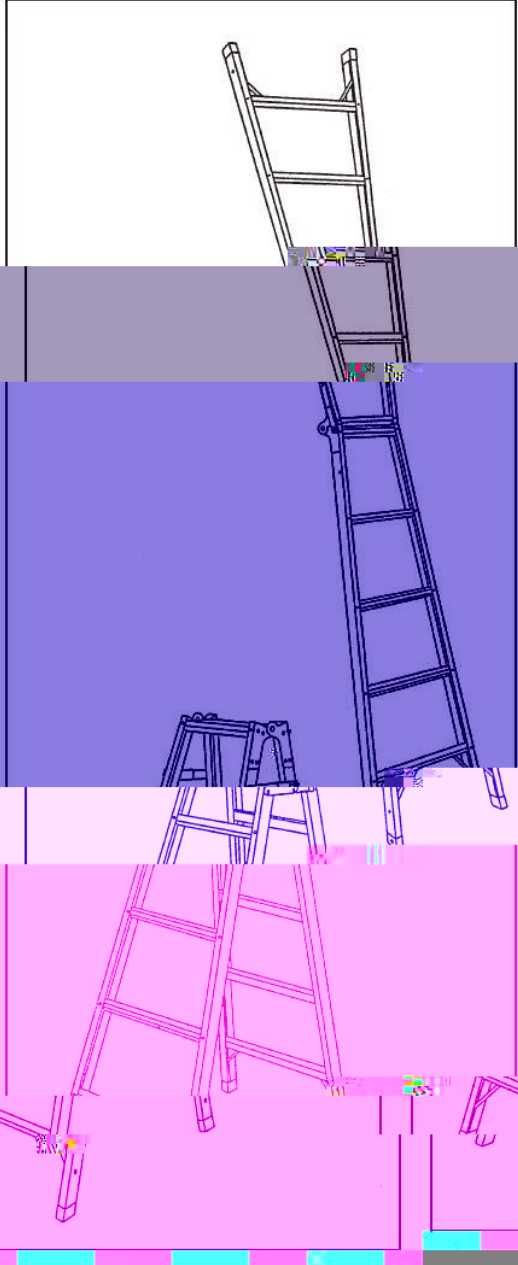

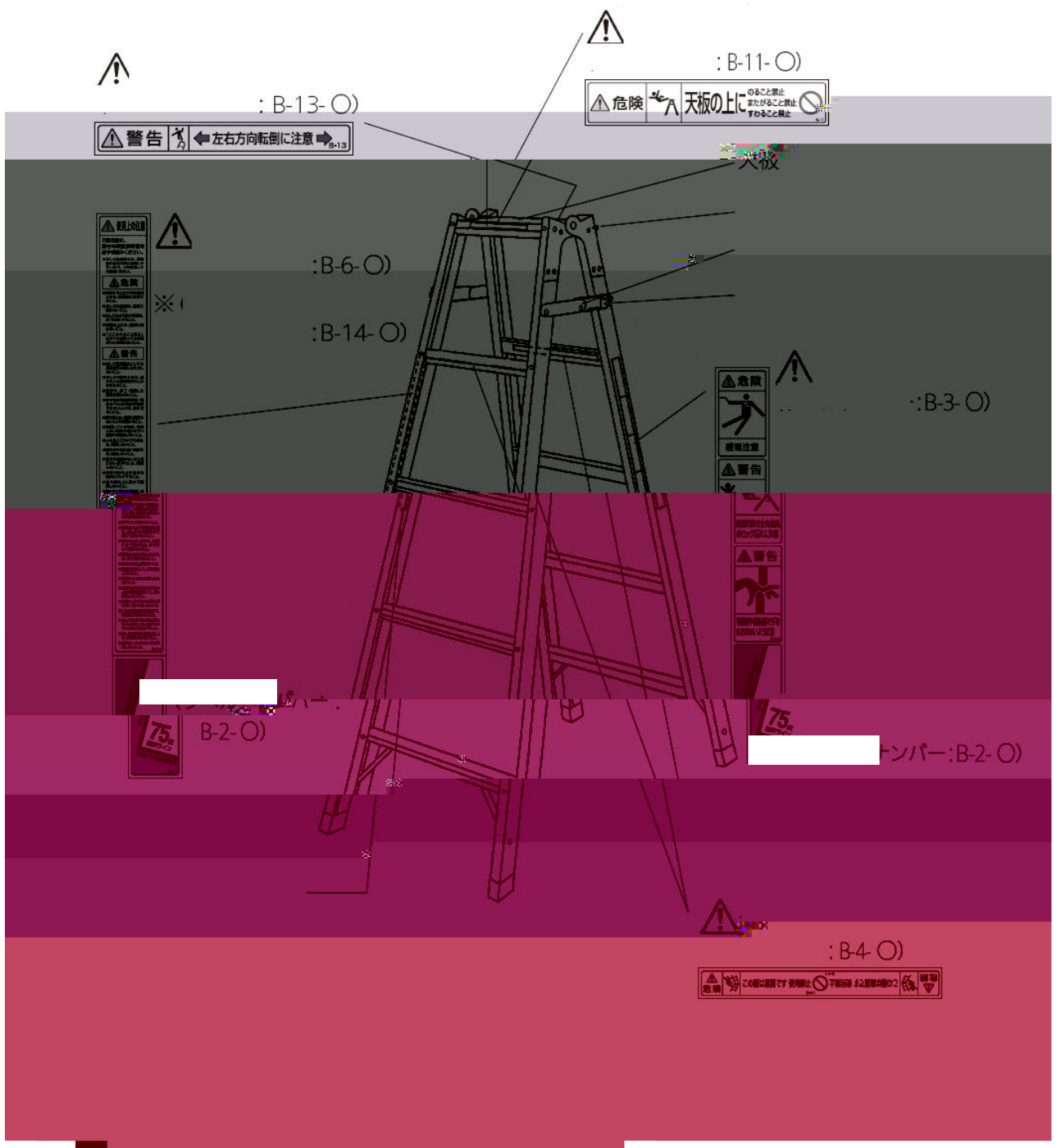

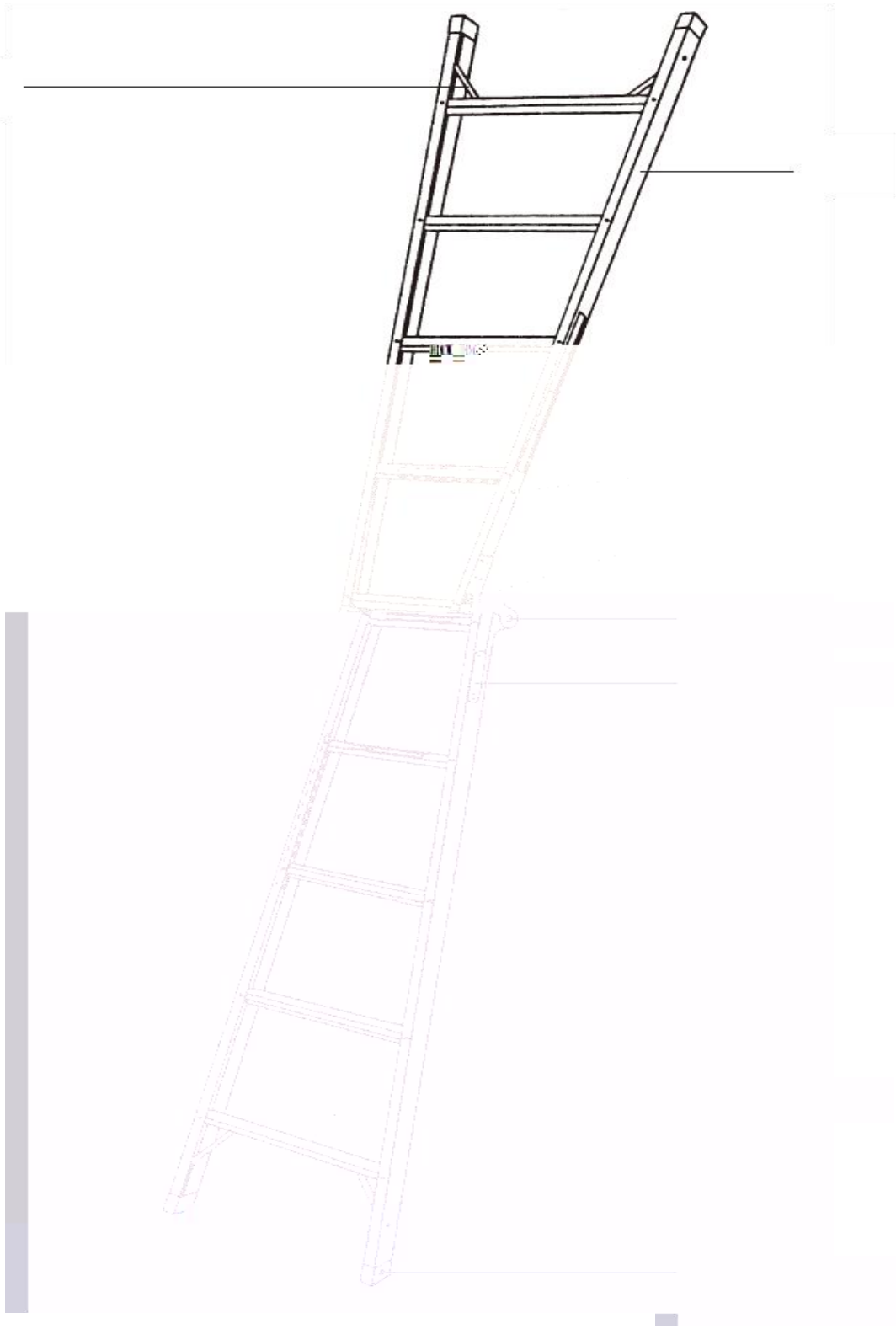

CC%

1



[]

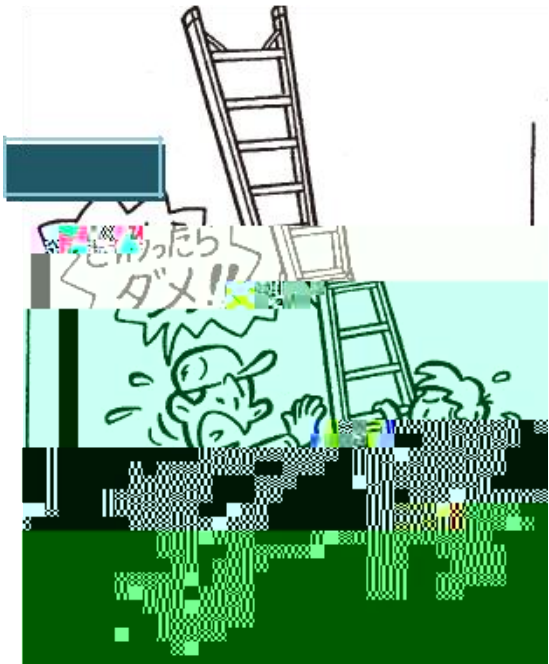



2

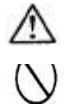

3.4

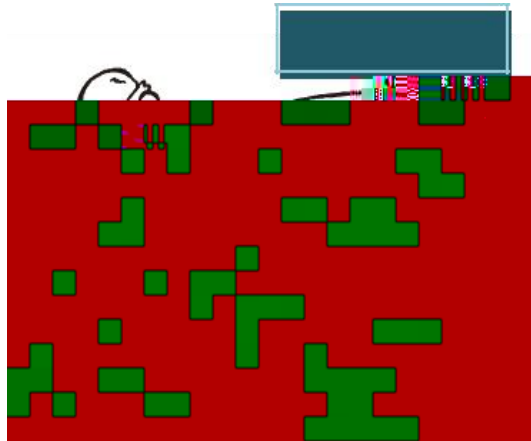

3



+X#€6 ñ * Ê XF EÃ

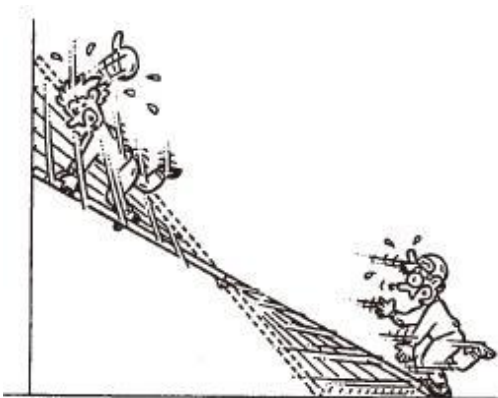
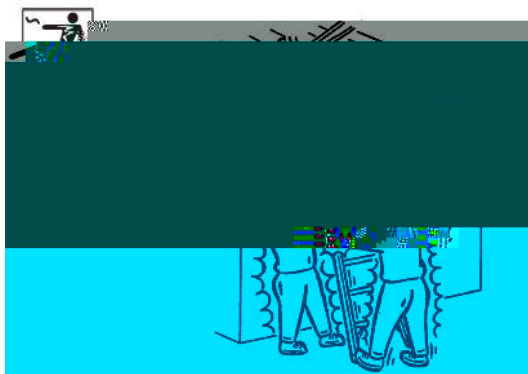

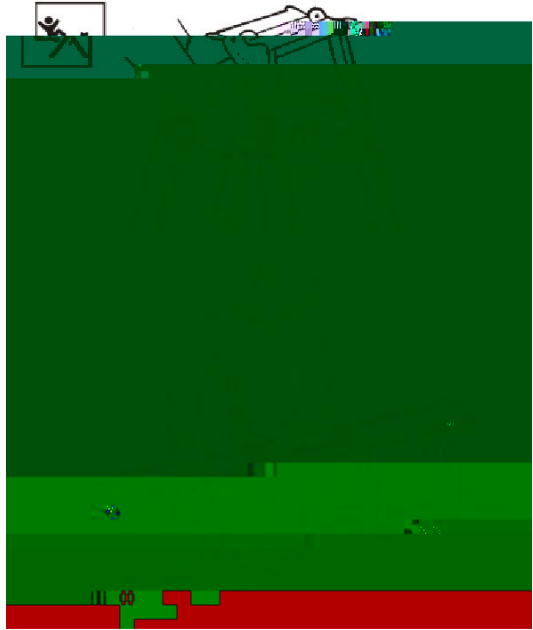
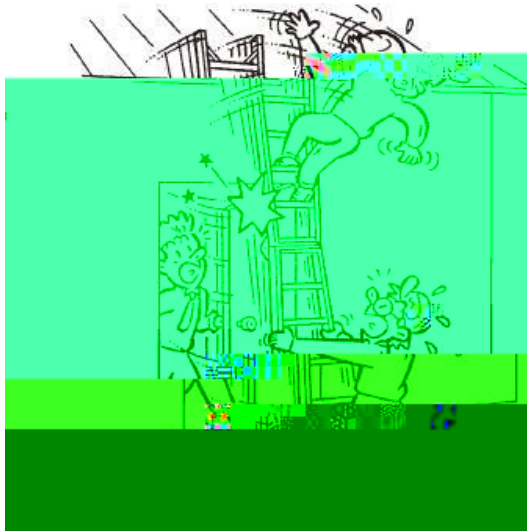

6

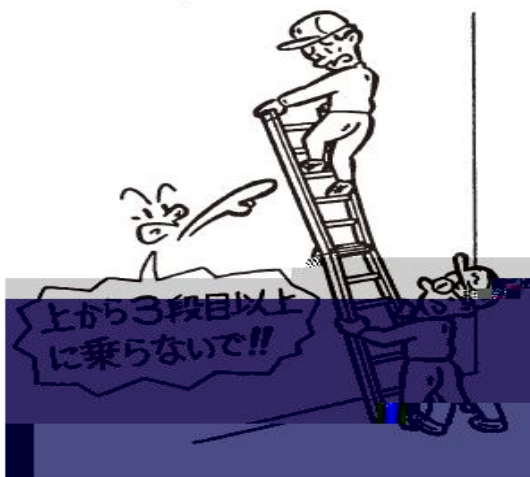
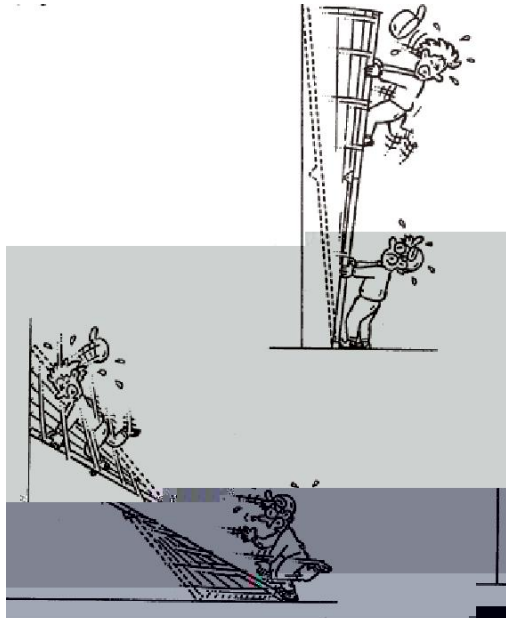
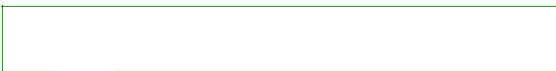

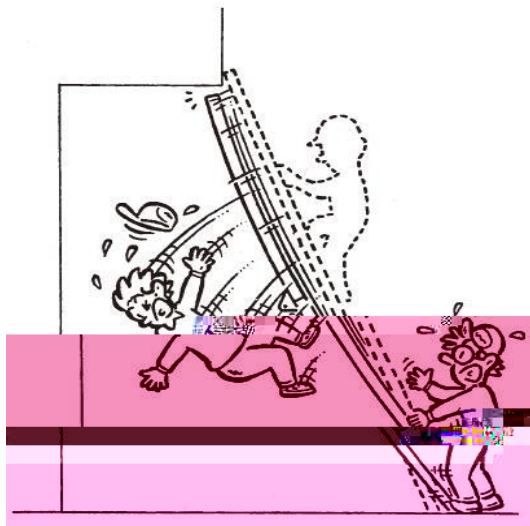

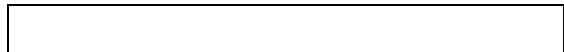
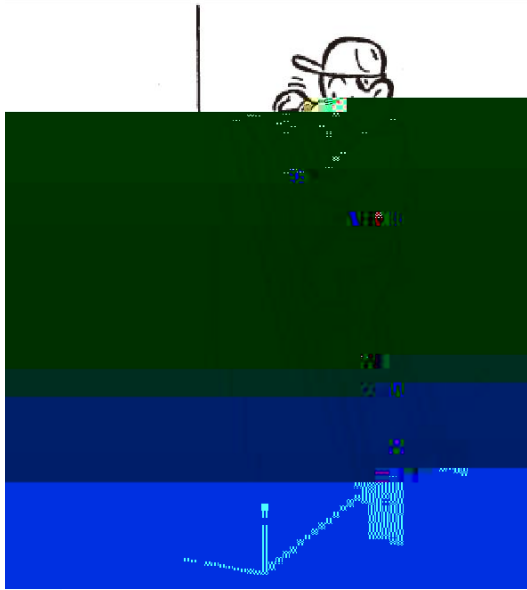

[
] 19

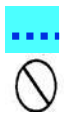

2

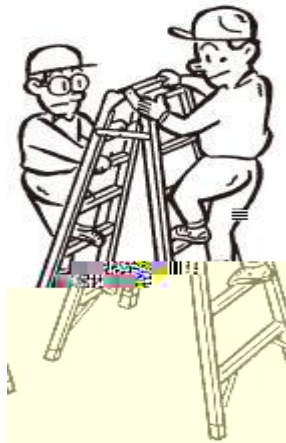

1 

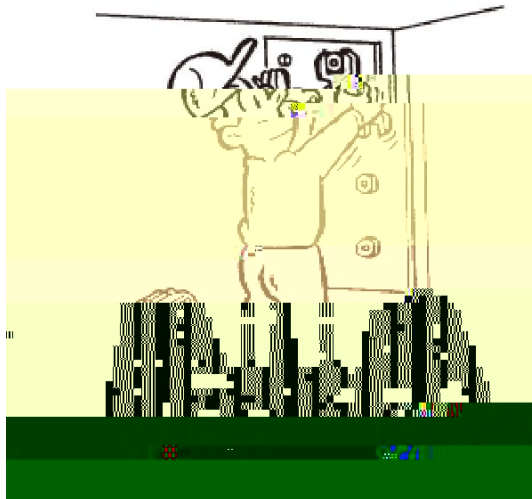
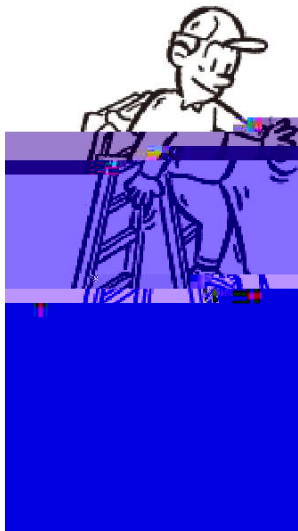

9



2

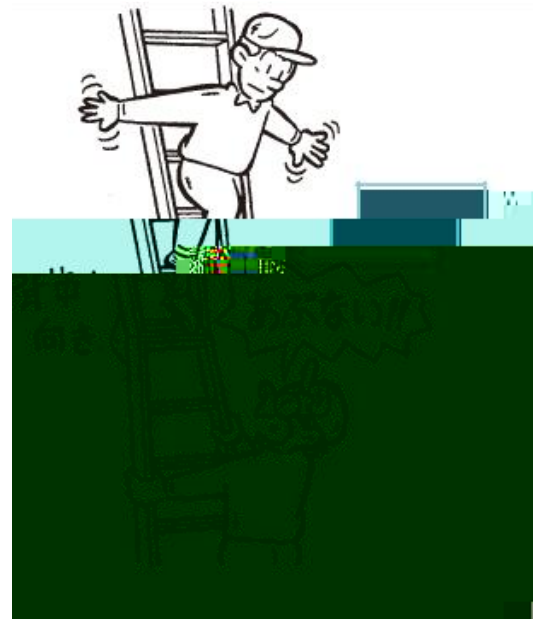



1

①

25

②

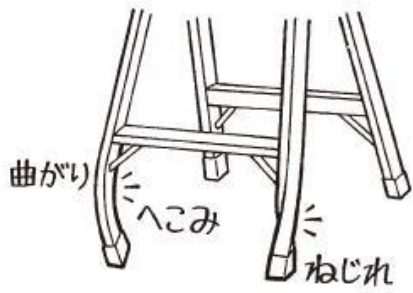

③

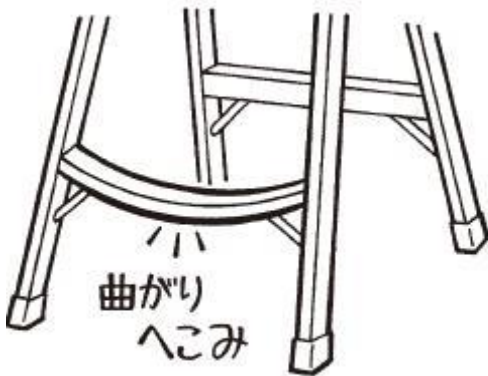

15

④

=

⑤

⑥

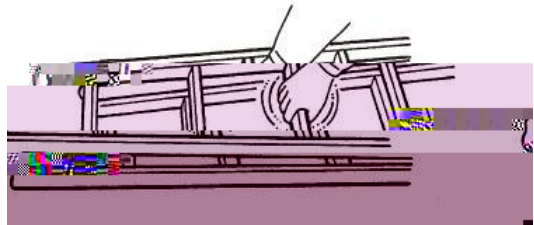

3

①



③

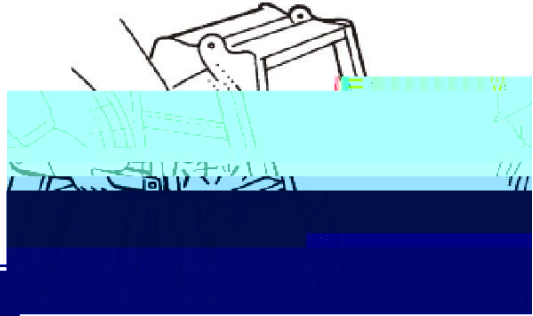

④

②

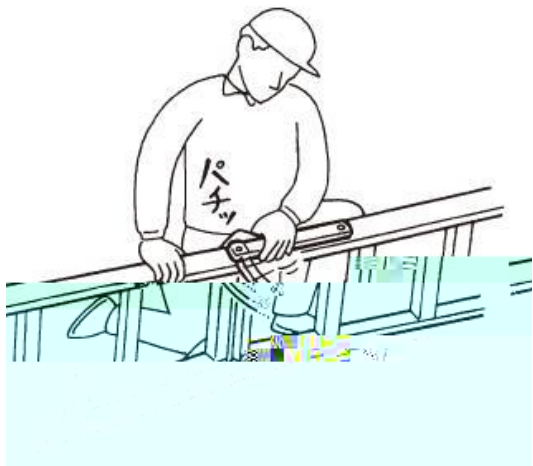
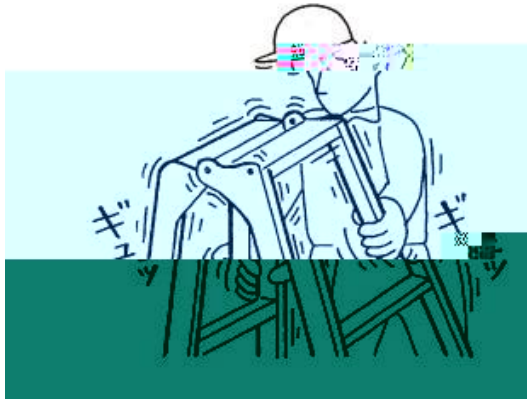

1



2



1

①

②

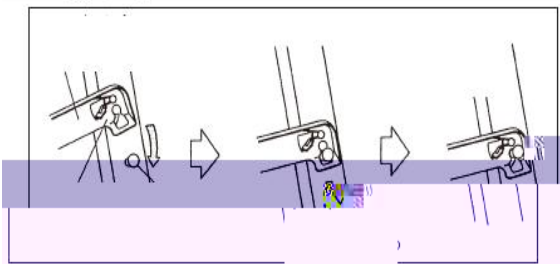

③

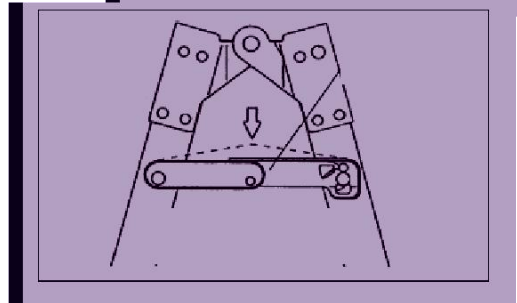
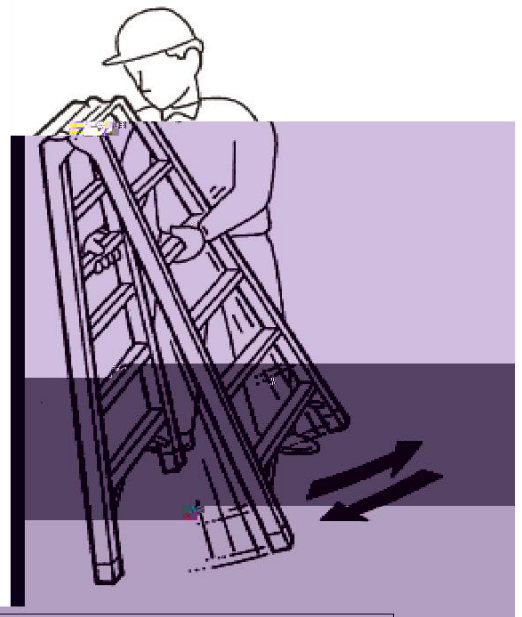

[]

①

[]

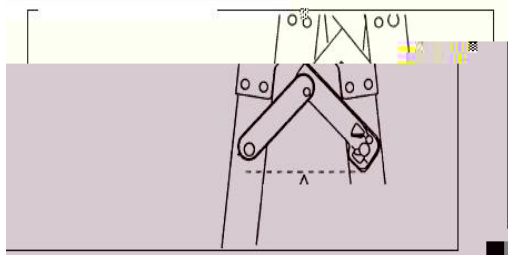

②

[]

①

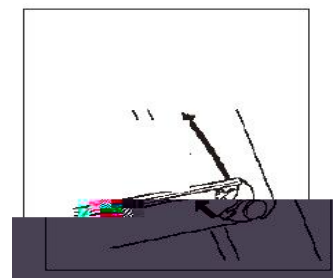

②

2

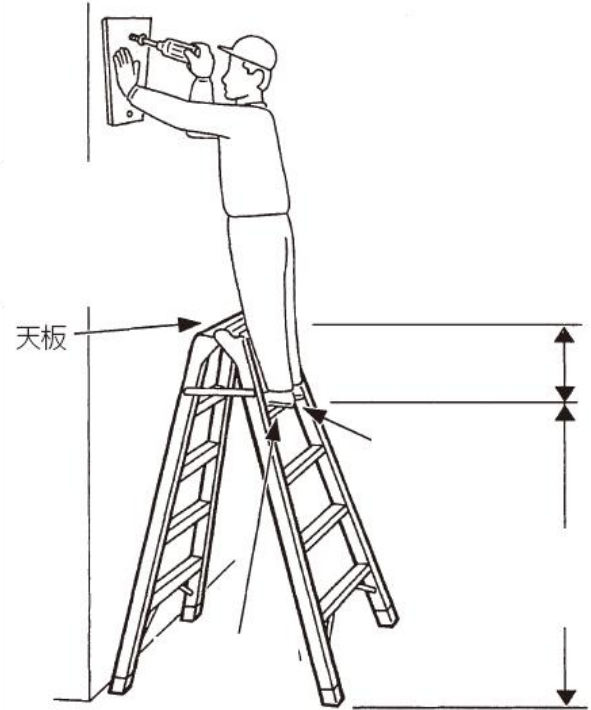

]

[

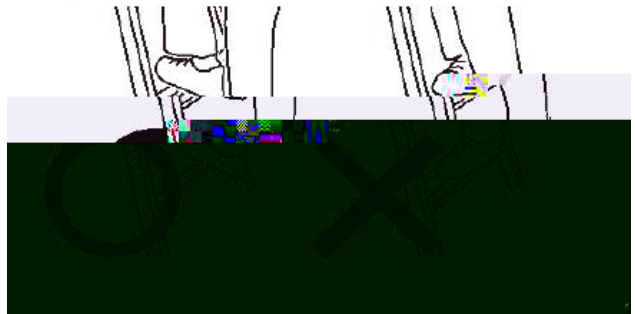

1

①

②

③

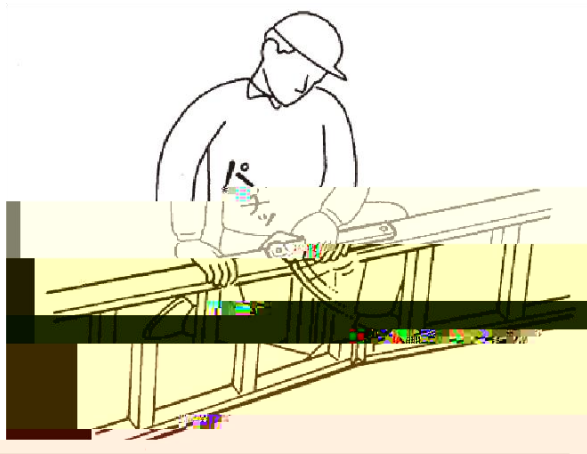
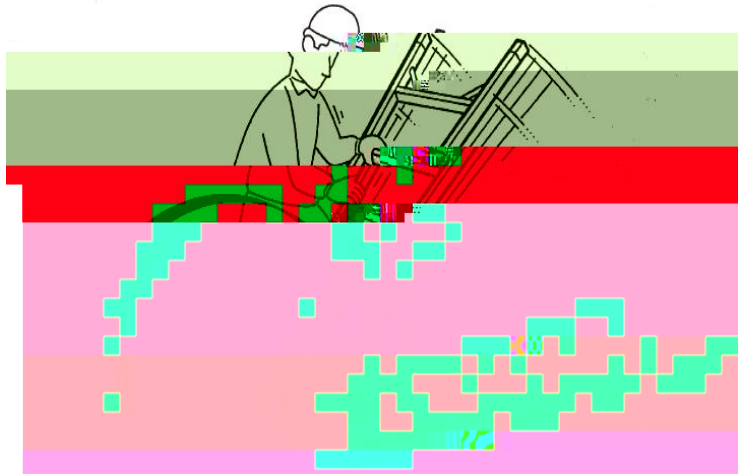

1

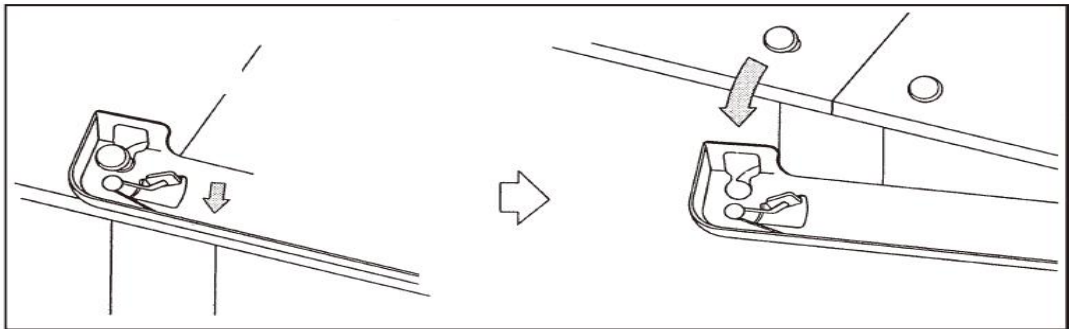

2

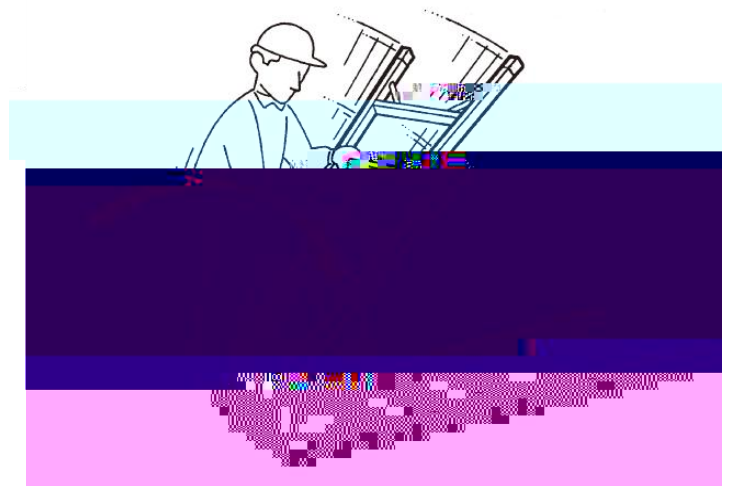

20

1

2



B

A

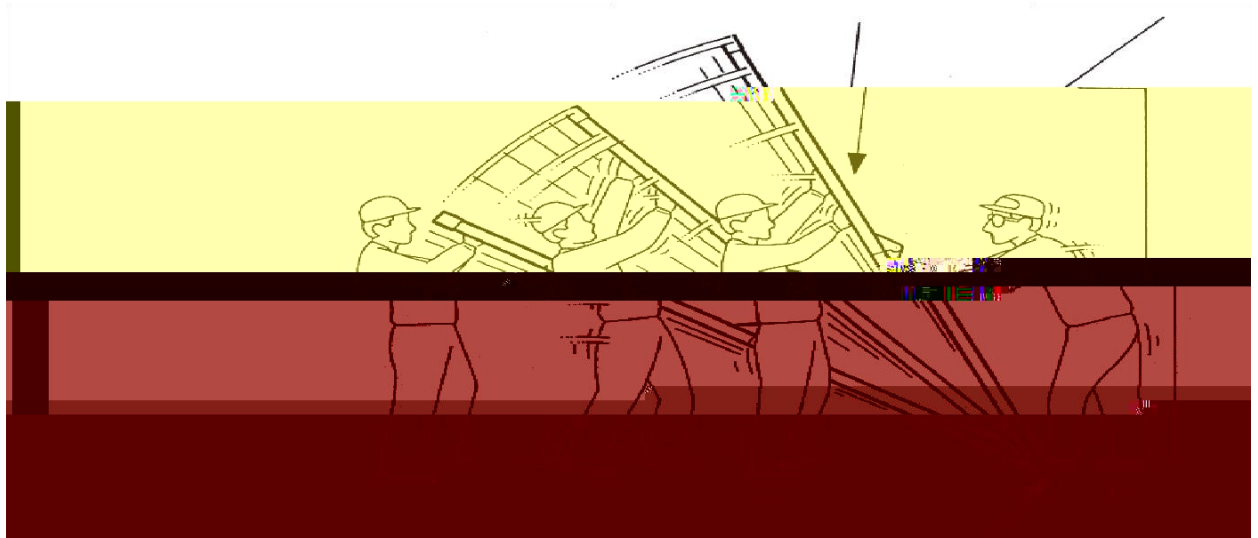
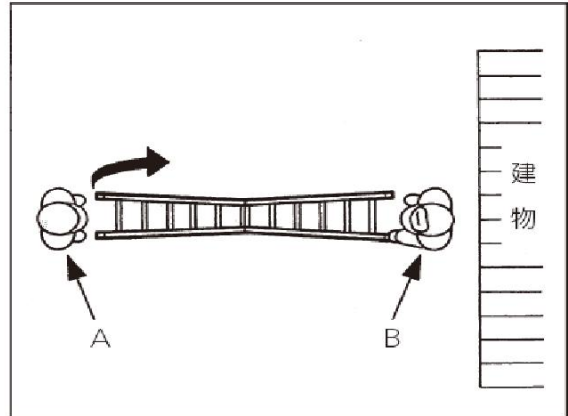

1 2

B



A

3

1

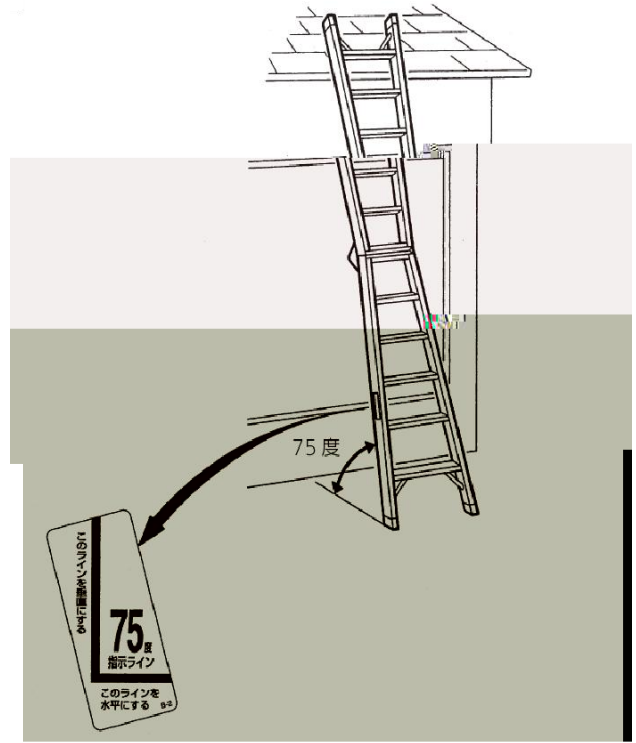

3

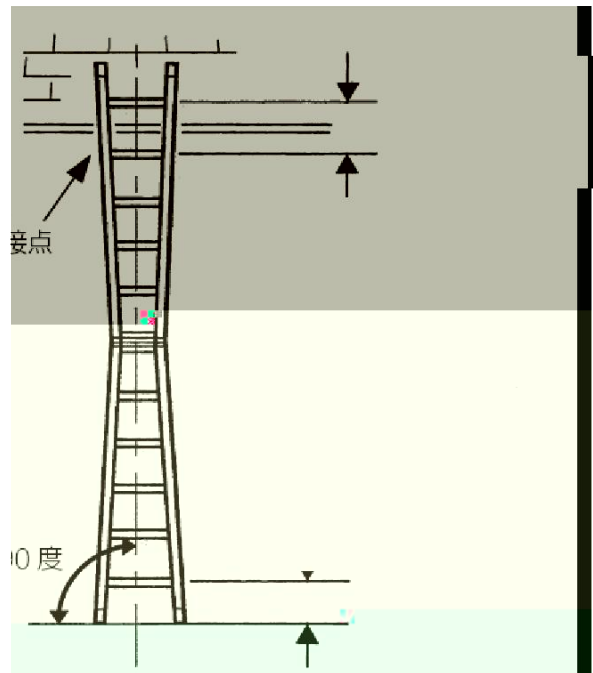

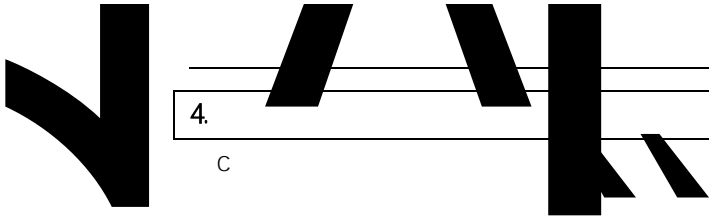

[!~9•00

]

~ ã ~ ã a ã a ~ a

2 Q U 9 00 B

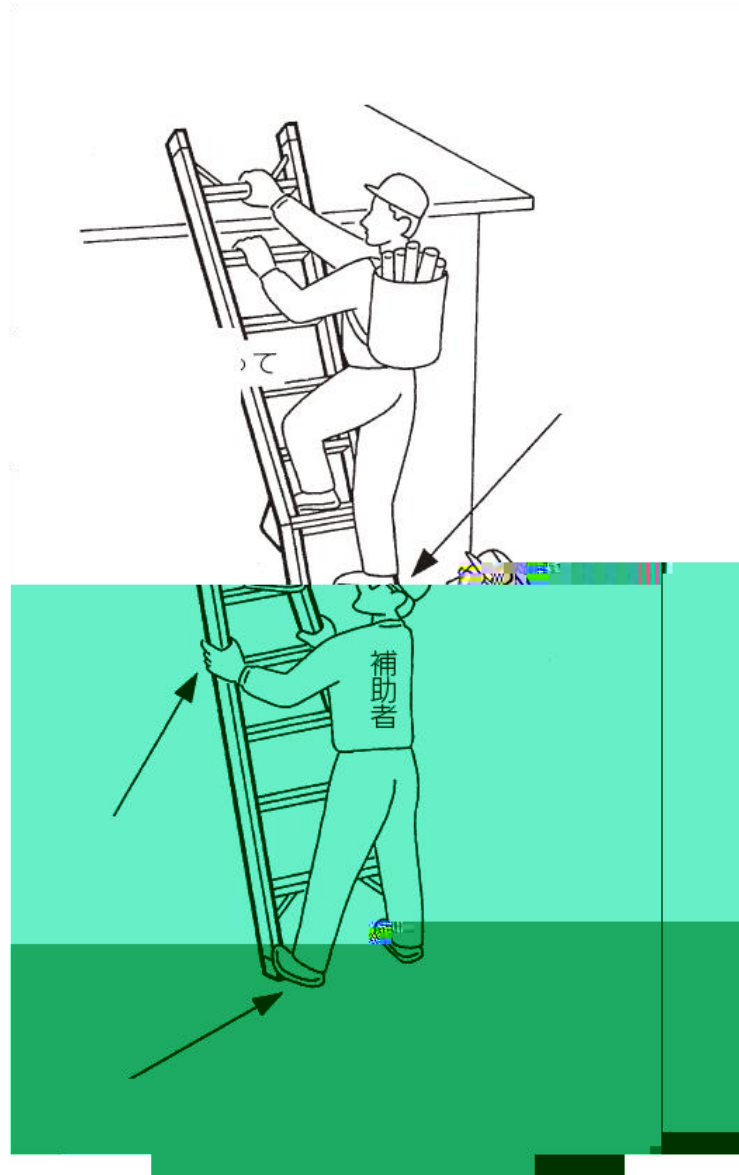

1



2

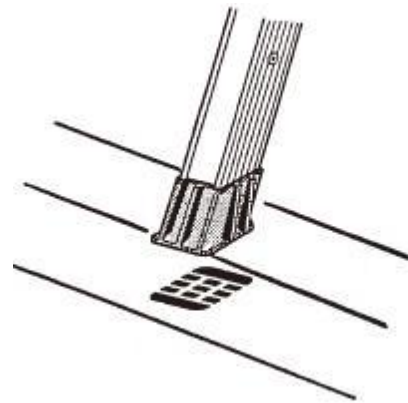
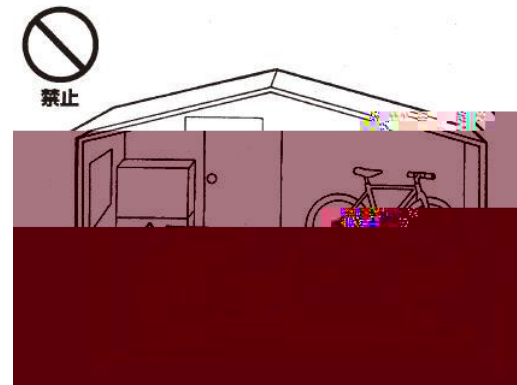

>

>



523475
0769- 83722500

188
0769- 83721270

200041
021- 62663633

167
021- 62663632

1603
